

MAGICFX® POWER SHOT



PRODUCT CODE : MFX0301
VERSION : 1.0
DATE : 11.12.2012



1. CONGRATULATIONS!

You have bought a great new product from MAGICFX®.

MAGIC FX is a Dutch manufacturer of professional special effects machines and equipment. We have been experts in special effects since our establishment in 1995. All our products are made under the brand name MAGICFX® which by now has acquired a great reputation on account of its quality and reliability. All products are made in accordance with the European Machinery Directive. MAGIC FX manages the entire production process in-house, from the design stages and prototyping to production. In short, we cover everything from concept to ready-to-use product.



Moreover, MAGIC FX is Europe's largest supplier of high-quality and fireproof confetti products and streamers. Thanks to our very large stock levels, we can deliver quickly and at low prices.

MAGICFX® is used by special effects professionals all over the world and our products are distributed through a dealer network which covers more than 80 countries.

Congratulations and enjoy your purchase!

MAG:CFX®

2. CE MARKING

	<p>PLEASE NOTE: We presume that you, your employees and others who use or come into contact with the machine are familiar with how the machine must be dealt with. This includes the correct use, maintenance and repair of the machine as described in this user manual. This also means that the employees are familiar with the use of machines through training or experience.</p>
	<p>DANGER WARNING: Only use the Power Shot in accordance with the regulations and instructions in this manual. Consult MAGIC FX in case of doubt.</p>

Disclaimers:

MAGIC FX B.V. excludes liability for unsafe situations, accidents and damage that are the result of:

- Disregard for the warnings or regulations as set out on the Power Shot or in this documentation.
- Use for other purposes or under other circumstances than those set out in this documentation.
- Alterations to the Power Shot. This also includes the use of replacement parts other than the original ones.
- Insufficient maintenance.
- Unauthorised removal of safety caps and/or safeguards.
- Incompetent operation of the machine.

MAGIC FX B.V. is not liable for any consequential loss in the event of a Power Shot breakdown.

© Copyright 2012

All rights are reserved. Nothing from this manual may be duplicated, or kept in an automated data file, or made public, or in any form or manner, whether electronically, mechanically, by photocopying, by incorporation, or in any other manner duplicated without the permission of MAGIC FX B.V.

MAGIC FX at all times retains the right to make alterations without the direct knowledge of the client. The contents of this user manual can also be changed.

Please contact the technical department of your supplier for extra information with regard to, for example, maintenance and repair. This user manual has been drawn up with the utmost care. MAGIC FX cannot be held responsible for any mistakes made in this publication or for any consequences thereof.

3. DECLARATION OF CONFORMITY

DECLARATION OF CONFORMITY
(according to Annex II.1.A of the Machinery Directive)



Concerning the Machinery Directive.
We; MAGIC FX B.V.
Schouwrooij 27
5281 RE Boxtel
The Netherlands

State under personal responsibility:
We are the manufacturer of the product:

MFX0301 - MAGICFX® Power Shot

to which this statement relates and which is in accordance with the provisions of the following Directive(s):

- Machinery Directive 2006/42/EC
- Low Voltage Directive 2006/95/EC
- EMC Directive 2004/108/EG

The following harmonising standards have been applied:

- NEN-EN-ISO 12100
- NEN-EN-ISO 60204-1

Place : Boxtel
Date : 15-10-2012

Name: MAGIC FX

A handwritten signature in black ink, consisting of a large, stylized 'B' followed by a series of loops and a long horizontal stroke extending to the right.

Director: B. Veroude





4. FOREWORD

This manual describes the MAGICFX® Power Shot. The information in this manual is important for the proper and safe functioning of the Power Shot. If you are not familiar with the installation, operation, preventative maintenance etc. of the Power Shot then please read this user manual carefully from beginning to end. MAGIC FX also insists that all new users (operators, installers, maintenance workers and cleaners) receive a training course in which this user manual can serve as a starting point.

MAGIC FX advises that the original of this user manual, including appendices, is kept at a safe and central place. It is best that another original or copy is kept close to the Power Shot at the workplace.

If you are familiar with these matters, then you can use this manual as a work of reference.

The following standard markings are used in this manual for drawing attention to certain subjects or actions.

	<p>TIP: Gives you suggestions and advice regarding easier or more convenient ways to carry out certain tasks.</p>
	<p>PLEASE NOTE: A comment with additional information: alerts you to certain problems.</p>
	<p>CAUTION: The machine can be damaged if you do not follow the procedures carefully.</p>
	<p>DANGER WARNING: You can get (seriously) hurt if you do not carefully carry out the procedures.</p>

CONTENTS

1.	CONGRATULATIONS!	1
2.	CE MARKING.....	2
3.	DECLARATION OF CONFORMITY.....	3
4.	FOREWORD	4
5.	INTRODUCTION	6
5.1	DESCRIPTION AND APPLICATION OF THE POWER SHOT.....	6
5.2	NECESSARY ACCESSORIES.....	6
5.3	CANNONS.....	6
6.	SAFETY	8
6.1	INTRODUCTION	8
6.2	GENERAL SAFETY RULES.....	8
6.3	WARNINGS.....	9
7.	PARTS	10
8.	ACCESSORIES.....	11
9.	PREPARATIONS	11
10.	INSTALLATION	12
11.	USAGE.....	15
12.	SWITCHING OFF.....	16
13.	TROUBLESHOOTING	17
14.	TECHNICAL SPECIFICATIONS	17
15.	MAINTENANCE	17
16.	GUARANTEE	17
17.	NOTES	18

5. INTRODUCTION

5.1 DESCRIPTION AND APPLICATION OF THE POWER SHOT

The Power Shot is a confetti shooting system which has been specially developed to easily shoot electric cannons from a podium or truss.

The Power Shot is splash proof and therefore suitable for outdoor locations.

The Power Shot can be used with electric confetti cannons as well as with electric streamer cannons.

As the Power Shot can be used in various ways, it is important to read this user manual carefully from beginning to end before you start operating the machine.

Any use other than that described above excludes your supplier from any liability.

5.2 NECESSARY ACCESSORIES

The following parts belong to the Power Shot:

		
Manual	MFX0308 – Power cable	Electric Cannon

Table 5.1

5.3 CANNONS

The Power Shot offers the possibility to work with approved electric confetti and streamer cannons. The Power Shot is not suitable for cannons other than those described below.

		
40cm Electric cannon	80cm Electric cannon	Andere confetti cannons

Table 5.2

The following types of electric cannons are possible:







TYPE CANNON	CONTENT	CANNON LENGTH	OUTPUT
	CONFETTI (150g)	40CM	5M
	STREAMERS (150g)	40CM	12M
	CONFETTI (300g)	80CM	12M
	STREAMERS (300g)	80CM	20M

Table 5.3

All pre-filled cannons are for one-off use only.

	DANGER WARNING: Metallic products are heavier and will therefore have a larger output.
	DANGER WARNING: The electric cannons contain pressure containers which fire off the confetti/streamers under a lot of pressure. Therefore always make sure there is a free shooting range.

6. SAFETY

6.1 INTRODUCTION

The Power Shot has been designed and constructed in such a manner that it can be used safely. This applies to the use, the circumstances and the regulations as described in this documentation. Reading this documentation and following the instructions are therefore necessary for everyone who is authorised to work with the Power Shot.

The Power Shot must be placed and used in surroundings that preferably:

- Have a reasonably stable temperature of between 0 and 30°C.
- Have a relative humidity degree of no more than 75%.
- Are reasonably free of dust, corrosive gases and high concentrations of organic vapours.
- Are not situated in the vicinity of a source of vibration.

6.2 GENERAL SAFETY RULES



- Only use the Power Shot if there are no people, animals or other objects in the direction of the electric cannon within the output distance. The shooting direction is the direction in which the electric cannon in the Power Shot is pointed. The output distance depends on the content and length of the electric cannons.
- Make sure that children, unauthorised people and animals do not obtain access to the Power Shot!
- Do not take hold of the Power Shot while it is working or is switched on. Also, when the Power Shot is not working, the electric cannon may still be filled.
- Safety devices may not be removed or disabled.
- All required safety devices must be in good condition and function properly.
- Ensure sufficient lighting of the surroundings.
- Keep the workplace clean.
- Only authorised persons may carry out work with the Power Shot.



6.3 WARNINGS

Warning texts have been attached to the Power Shot. With regard to these the following rules apply:

- These texts may not be removed or damaged. The operator must regularly check if this is the case.
- The operator must ensure that the texts are and remain clearly visible and legible.

	<p>DANGER WARNING: One must replace texts or signs if these are absent, damaged or illegible.</p>
---	--

Sign and explanation	Photo
<div data-bbox="395 678 593 875" data-label="Image">  </div> <p data-bbox="304 909 679 940">PIC 616 Follow the instructions</p> <p data-bbox="205 974 775 1064">The operator must be told that he/she may only operate the Power Shot after reading the user manual.</p> <p data-bbox="205 1095 767 1187">A warning is given for this by means of the command sign of PIC 616. This sign should be attached to the type sign. See also the photo.</p>	

Sign and explanation	Photo
<div data-bbox="395 1406 593 1574" data-label="Image">  </div> <p data-bbox="312 1624 671 1655">PIC 307 Danger: high voltage</p> <p data-bbox="205 1684 770 1807">A warning must be given about the machine's high voltage by using the caution sign PIC 307. This sign must be attached to the Power Shot. See also the added photo.</p>	

7. PARTS

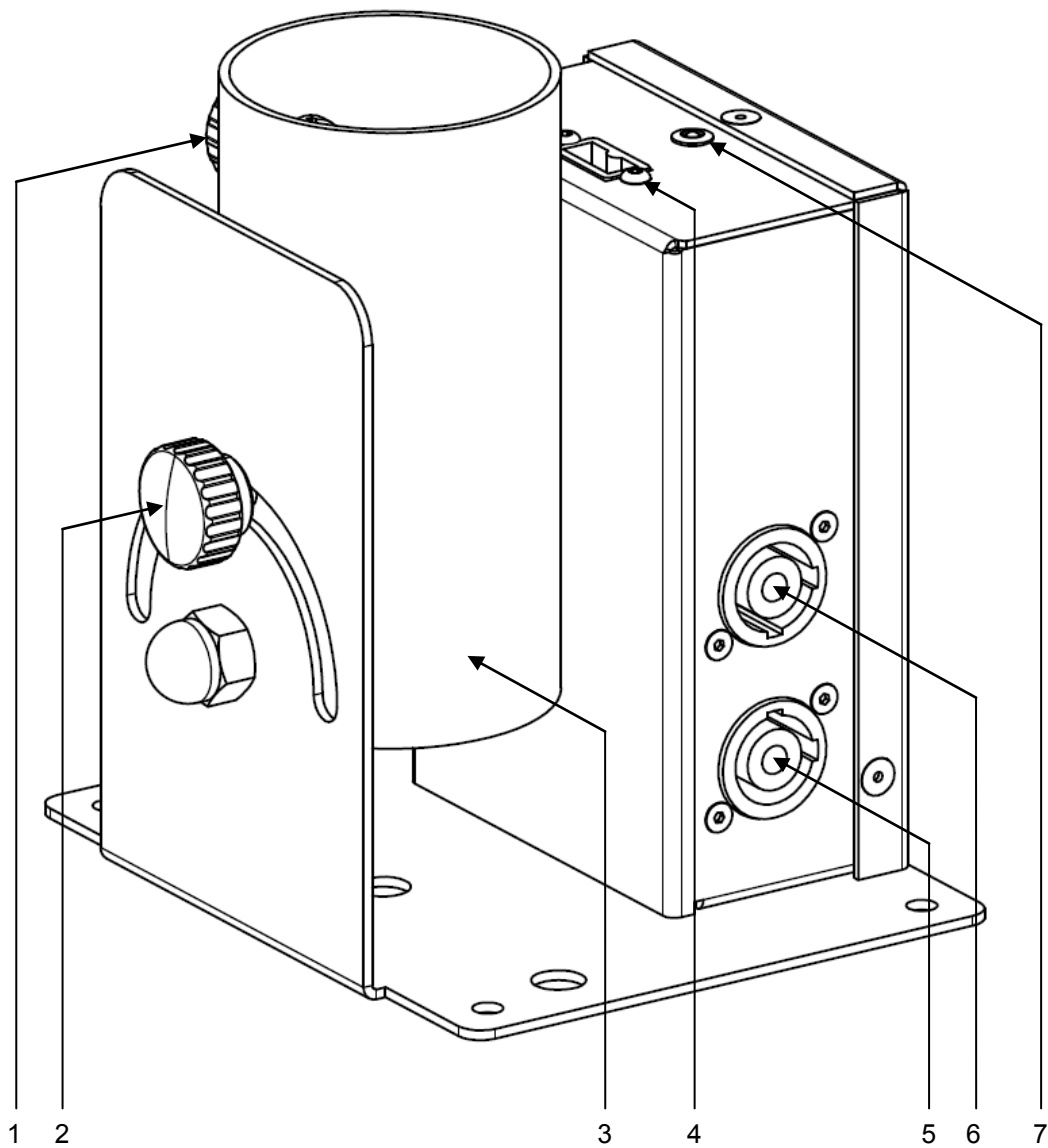

1. Cannon screw nut
2. Richt screw nut
3. Cannon tube
4. Cannon connector
5. powerCON input
6. powerCON output
7. LED indicator

8. ACCESSORIES

		
MFX0302 – Cannon clamp	MFX3103 – Twenty clamp M10	MFX0303 – Base Plate
		
MFX0309 – Power link cable	MFX0308 – Power cable	MFX3303 – Case for 4 Power Shots

Table 8.1

You can order these parts and accessories from:



MAGIC FX B.V.
Schouwrooij 27
NL-5281 RE BOXTEL
The Netherlands
T. +31(0)411 63 50 13
F. +31(0)411 63 50 12
W. <http://www.magicfx.eu>
E. info@magicfx.eu



9. PREPARATIONS

Unpack the Power Shot. Dispose of the packaging material without harming the environment. Inspect the machine for any damage. If damage is noticed this must be reported to MAGIC FX.

10. INSTALLATION

	<p>CAUTION: The machine can be damaged if you do not follow the procedures carefully.</p>
	<p>DANGER WARNING: The MAGICFX® Power Shot may only be installed by adults and authorised persons.</p>

Prepare the Power Shot for use as follows:

1a



Place the Power Shot on an even, solid and stable surface and secure it with the notches made for this.

Then continue to step 2.



Attach the Power Shot to a Base Plate for an extra stable surface. It is possible to attach 1, 2 or 4 Power Shots to the Base.

1b

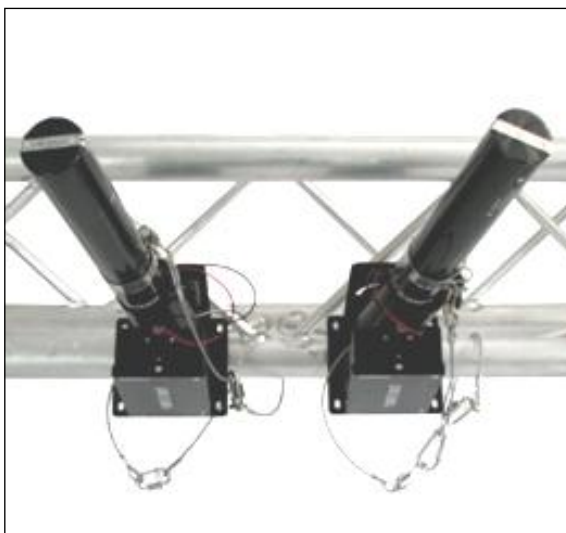

If you want to use the Power Shot while mounted in a truss system, then attach 2 certified truss clamps (MFX3103) to the underside of the Power Shot. Next, place the Power Shot on the required place in the truss system and firmly turn the clamp.

Then continue to step 2.



Always use a safety cable to secure the Power Shot when it is suspended.

2.



Connect a powerCON cable to provide the Power Shot with 230V~ 50/60Hz. You can connect several Power Shots to each other by using a powerCON loop cable (MFX0309).



Only use grounded electricity sockets! Ensure that the powerCON cable is not connected to the power supply when it is put in the Power Shot.

3.



Test the working of the Power Shot by connecting the powerCON cable to the power supply. As soon as the blue LED-light above the Power Shot lights up you know that the Power Shot is properly connected. After testing, make sure that the PowerCON cable is no longer directly connected to the power supply.



During testing, make sure that no electric cannons are connected to the Power Shot.

4.



Place the electric cannon in the cannon holder.



The electric cannon can detach itself through the pressure that is released during the shooting. Therefore always use a Cannon Clamp to secure it to the Power Shot. This is especially important when using it in a truss.

5.



Secure the electric cannon with a screw nut which is situated on the side of the holder.



Never turn the screw nuts tighter than necessary. This can damage the pressure pattern in the electric cannon.

6.



Once the electric cannon has been placed in the Power Shot it can be adjusted to the correct shooting direction. Unscrew the adjustment button on the side of the Power Shot for setting the holder in the correct direction.



Never shoot in the direction of people, animals or objects. Also consult this manual for the shooting distance of the various cannons.

7.





Plug in the electric cannon connector in the right way into the connector on top of the Power Shot. This connector has a slot which insures that the connector can be inserted in only one way.



Before plugging in the connector check if the blue LED is lighting up. If so the cannon will be shot when u plug the cannon in!

11. USAGE

	<p>TIP: Gives you suggestions and advice regarding easier or more convenient ways to carry out certain tasks.</p>
	<p>CAUTION: The machine can be damaged, if you do not follow these procedures carefully.</p>
	<p>DANGER WARNING: The MAGICFX® Power Shot may only be installed by adults and authorised persons.</p> <p>The Power Shot may only be operated if all parts are completely and correctly installed/connected.</p>

For using the Power Shot take the following steps:

1.



When the Power Shot is provided with electricity the attached cannon will shoot.



Make sure that you only shoot when there are no people, animals or objects in the shooting range of the cannon.





The Power Shot can be operated by means of DMX. To this end use a DMX FX Switchpack.



Make sure that you always have the Power Shot within your sight.

12. SWITCHING OFF

To switch off the Power Shot, take the following steps:

1.



Make sure that the Power Shot is no longer connected to an electricity source.

Only then remove the powerCON cable.

2.



Remove the cannon from the Power Shot.

13. TROUBLESHOOTING

- **The machine does not turn on.**

Check if the powerCON cable is properly connected.

- **A cannon does not work.**

Check if the connector of the cannon is properly connected. If so, exchange the cannon with another and see if this one works.

- **The output is not 12VAC**

The electronics in the Power Shot will fully be activated when a load like a cannon is attached.

- **The Power Shot is still malfunctioning after troubleshooting**

Always contact your dealer or the technical service of MAGIC FX first in case of uncertainties, questions about the Power Shot works or other issues with regard to the Power Shot.

14. TECHNICAL SPECIFICATIONS

Measurements and weight	Length:	150mm (5.9")
	Width:	145mm (5.5")
	Height:	166mm (6.5")
	Weight:	1.7 (3.75lbs.) without cannon
Power	Input:	AC 230V~50-60Hz
	Output:	AC 12V~50-60Hz
	Usage:	100W
	Fuse:	Short circuit security

Design and product specifications can be changed without prior notification.

15. MAINTENANCE

To achieve the maximum service life of the Power Shot you must regularly clean the Power Shot and test if it is working correctly.

Should the Power Shot not work for some reason then please contact MAGIC FX.

	<p>DANGER WARNING: Do not replace parts yourself; always consult MAGIC FX if necessary.</p>
---	--

16. GUARANTEE

A manufacturer's guarantee of 3 years applies to the MAGIC FX Power Shot.

- The guarantee expires if the Power Shot is used for improper purposes and for applications which are not stated in this manual.
- The guarantee also expires if the machine is used incorrectly or in violation of the regulations.
- The guarantee expires if the machine is altered without permission from the supplier.

